

# PRODUCT DATASHEET

## DL COMFORT DN 130 13 W 3CCT IP54 WT

DOWNLIGHT COMFORT | Downlights with adjustable white light colors



### Areas of application

- Direct replacement for luminaires with compact fluorescent lamps
- General illumination
- Bathrooms
- Kitchens
- Offices
- Corridors
- Foyers
- Shops
- Stairways

### Product benefits

- Three light color in one luminaire: Warm White, Cool White, Daylight White
- Simple installation thanks to integrated driver
- Easy installation with fast connection
- 5 years guarantee

### Product features

- Three light colors selectable via slide switch
- Type of protection: IP54
- Connector box with push wire terminal for tool-free connection
- Through wiring possible



## TECHNICAL DATA

### Electrical data

|   |                       |
|---|-----------------------|
| Nominal wattage   | 13.00 W               |
| Nominal voltage   | 100...277 V           |
| Mains frequency   | 50...60 Hz            |
| Nominal current   | 140 mA                |
| Inrush current  | 40 A                  |
| Inrush current time $T_{h50}$                               | 100 $\mu$ s           |
| Max. number of luminaires per miniature circuit breaker B16 | 18                    |
| Max. number of luminaires per miniature circuit breaker C10 | 15                    |
| Max. number of luminaires per miniature circuit breaker C16 | 24                    |
| Power factor $\lambda$                                      | > 0.90                |
| Total harmonic distortion                                   | < 20 %                |
| Protection class  | I                     |
| Operating mode  | Integrated LED driver |

### Photometrical data

|  |   |
|--|---|
| Luminous flux                                | 1030 lm / 1210 lm / 1110 lm <sup>1)</sup> |
| Luminous efficacy                            | 85 lm/W <sup>2)</sup>                     |
| Color temperature                            | 3000 K / 4000 K / 5700 K                  |
| Light color (designation)                    | Warm White / Cool White / Cool Daylight   |
| Color rendering index Ra                     | > 80                                      |
| Standard deviation of color matching         | < 5 sdc <sub>m</sub>                      |
| Luminous intensity                           | -   |
| Flickering metric (Pst LM)                   | -   |
| Stroboscope effect metric (SVM)              | -   |
| Photobiological safety group acc. to EN62778 | RG0                                       |
| Photobiological safety group acc. to EN62471 | RG0                                       |
| Beam angle                                   | 60 °                                      |
| UGR  | < 22                                      |

1) Luminous flux dependent on selected color temperature: 1030 lm@3000 K / 1110 lm@5700 K / 1210 lm@4000 K

2) Value at 5700 K, different for other color temperatures

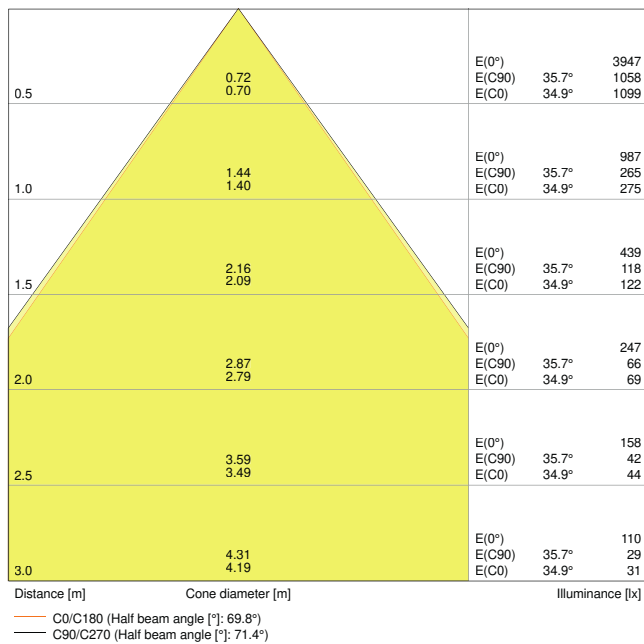

DL COMFORT DN130 13W3CCT 60DEG WT-4000K

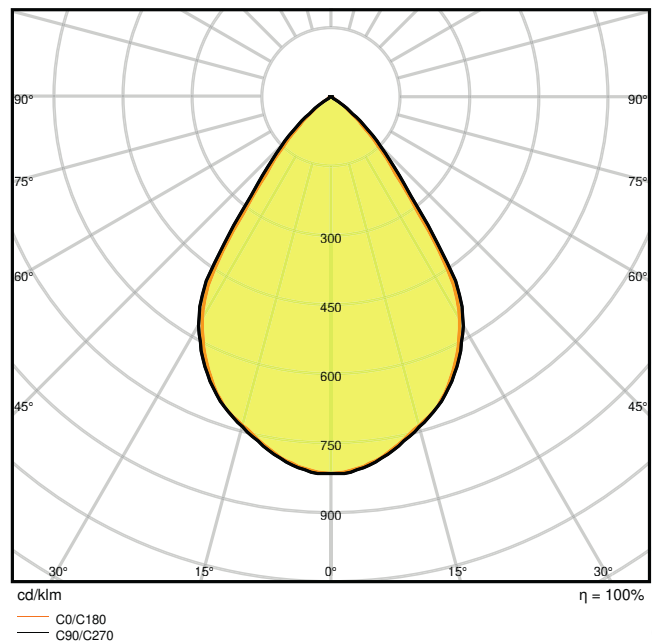

DL COMFORT DN130 13W3CCT 60DEG WT-4000K

Dimensions & Weight

|                |           |
|----------------|-----------|
| Diameter       | 145.00 mm |
| Height         | 82.00 mm  |
| Product weight | 265.00 g  |

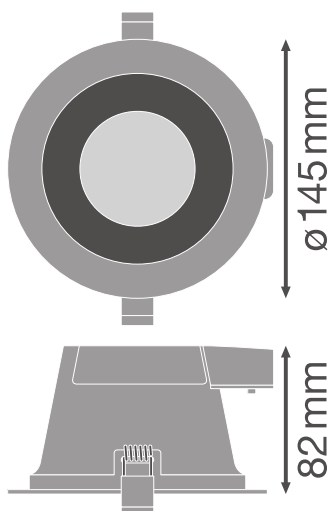

DL COMFORT DN130 13W

## Materials & Colors

|  |                               |
|--|-------------------------------|
| Product color                              | White                         |
| Housing color                              | White                         |
| Body material                              | Aluminum                      |
| Cover material                             | Polymethylmethacrylate (PMMA) |
| Glow Wire Test according to IEC 60695-2-12 | 650 °C                        |
| Mercury content                            | 0.0 mg                        |

## Application & Mounting

|  |                            |
|--|----------------------------|
| Ambient temperature range              | -20...+45 °C               |
| Type of connection                     | Screwless terminal, 2-Pole |
| Type of protection                     | IP54/IP20                  |
| Protection class IK (shock resistance) | IK03                       |
| Dimmable                               | No                         |
| Mounting type                          | Recessed                   |
| Mounting location                      | Ceiling                    |
| Application environment                | Indoor                     |
| Mounting diameter                      | 130 mm                     |
| Mounting depth                         | 125 mm                     |
| LED module replaceable                 | Not replaceable            |
| With light source                      | Yes                        |

## Lifespan

|                            |                       |
|----------------------------|-----------------------|
| Lifespan L70/B50 at 25 °C  | 50000 h <sup>1)</sup> |
| Lifespan L80/B10 at 25 °C  | 43000 h <sup>1)</sup> |
| Lifespan L90/B10 at 25 °C  | 30000 h               |
| Number of switching cycles | 50000                 |

<sup>1)</sup> t[h]: L70 / B50 @ 25 °C (Ta), t[h]: L80 / B10 @ 25 °C (Ta), t[h]: L90 / B10 @ 25 °C (Ta)















## Certificates & Standards

|  |                          |
|--|--------------------------|
| Standards  | CE / CB / ENEC / TÜV SÜD |
| Luminaire with limited surface temperature, "D sign" | No                       |
| Ball shot safe                                       | No                       |

## Additional product data

|                       |              |
|-----------------------|--------------|
| Number of illuminants | Not relevant |
| Added function        | MULTI SELECT |

DOWNLOAD DATA

| Documents and certificates   |                                 | Document name                                       |
|--|---------------------------------|---|
|    | User Instruction                | DL COMFORT 3CCT                                     |
|    | Legal information               | LI DL COMFORT                                       |
|    | Legal information               | LSI_DL COMFORT 3 CCT                                |
|    | Legal information               | Informationstext 18 Abs 4 ElektroG                  |
|    | Declarations of conformity      | Attestation-of-Conformity DOWNLIGHT Comfort TÜV     |
|    | Declarations of conformity      | EU Declaration of Conformity DOWNLIGHT Comfort LEDV |
|  | Declarations Of Conformity UKCA | DOWNLIGHT COMFORT / DL UGR19                        |
| Photometric and lighting design files  |                                 | Document name                                       |
|  | IES file (IES)                  | DOWNLIGHT COMFORT 13W 3CCT                          |
|  | LDT file (Eulumdat)             | DL COMFORT DN130 13W3CCT 60DEG WT-4000K             |
|  | ULD file (DIALux)               | DL COMFORT DN130                                    |
|  | ROLF file (RELUX)               | DL COMFORT DN130                                    |
|  | UGR file (UGR table)            | DL COMFORT DN130 13W3CCT 60DEG WT-4000K             |
|  | LDC typ cone                    | DL COMFORT DN130 13W3CCT 60DEG WT-4000K             |
|  | LDC typ polar                   | DL COMFORT DN130 13W3CCT 60DEG WT-4000K             |
| CAD/BIM files  |                                 | Document name                                       |
|  | CAD_STEP_3D                     | DL COMFORT DN130                                    |

| Tender texts   | Document name                              |
|--|--|
|  Tender documents | DOWNLIGHT COMFORT 130 13 W 3CCT IP54 WT-EN |

**LOGISTICAL DATA**

| Product code  | Packaging unit (Pieces/Unit) | Dimensions (length x width x height) | Gross weight | Volume                |
|---------------|------------------------------|--------------------------------------|--------------|-----------------------|
| 4058075104068 | Folding box<br>1             | 170 mm x 170 mm x 125 mm             | 326.00 g     | 3.61 dm <sup>3</sup>  |
| 4058075104075 | Shipping box<br>8            | 360 mm x 360 mm x 270 mm             | 3640.00 g    | 34.99 dm <sup>3</sup> |

The mentioned product code describes the smallest quantity unit which can be ordered. One shipping unit can contain one or more single products. When placing an order, for the quantity please enter single or multiples of a shipping unit.

**ADDITIONAL CATALOG INFORMATION**

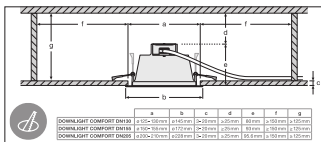
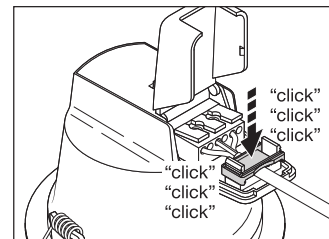
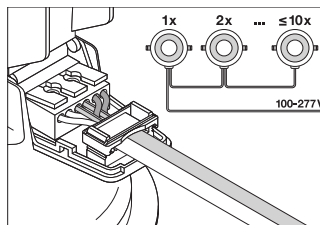
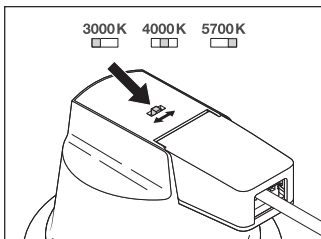

**References / Links**

– For Guarantee see [www.ledvance.com/guarantee](http://www.ledvance.com/guarantee)

**DISCLAIMER**

Subject to change without notice. Errors and omission excepted. Always make sure to use the most recent release.